

Stalci za bicikle · Bicycle stands · Fahrradständer · Porta biciclette

HR Nadstrešnice za bicikle izrađene su od pocinčanog čelika zaštićenog zapečenim prahom, obloga je od dvoslojnog polikarbonata.

EN Shelters for bicycles are made of zinc-plated steel protected by powder coating, cover is made of a double-layer polycarbonate.

DE Die Regenschütze für die Fahrräder werden aus dem verzinkten Stahl aus gefertigt, mit dem Pulverbeschichtung geschützt. Der Belag ist aus Zweischichten Polykarbonate.

IT I parasoli per i biciclette sono fate dal acciaio zincato protetto dal rivestimento della polvere, il rivestimento e da polycarbonato doppio.



1800

m=360 kg

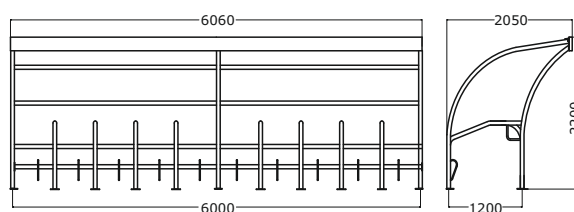

1801

m=210 kg

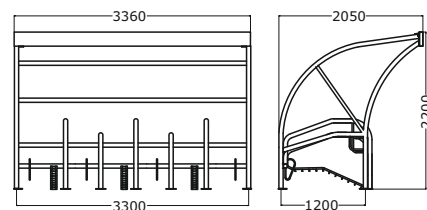

1805

m=240 kg

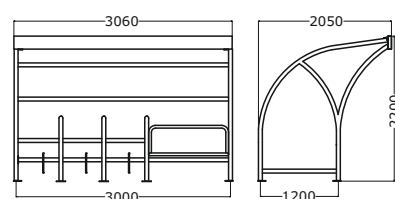

Stalci za bicikle · Bicycle stands · Fahrradständer · Porta biciclette

HR Stalci za bicikle su izrađeni od pocinčanog čelika zaštićenog zapečenim prahom.

EN Bicycle stands are made from zinc-plated steel protected with powder coating.

DE Die Fahrradständer aus dem verzinkten Stahl, mit den Pulverbeschichtung geschützt.

IT I Portabiciclette dal acciaio zincato protetto dal rivestimento della polvere.



4000

m=35 kg

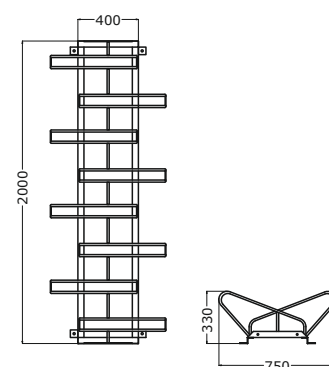

4001

m=50 kg

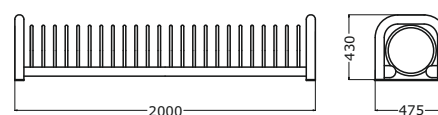

4002

m=47 kg

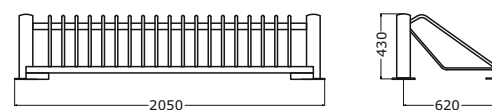

Stalci za bicikle · Bicycle stands · Fahrradständer · Porta biciclette



4003

m=41 kg

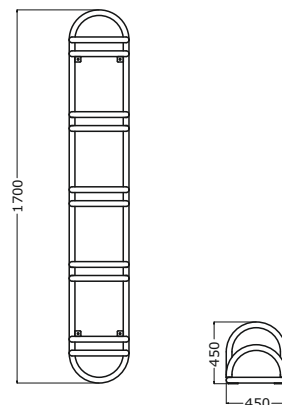

4004

m=22 kg

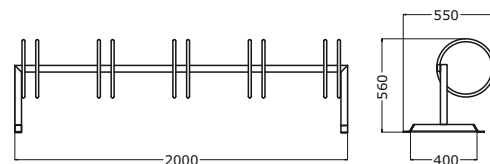

4010

HR Serija "PADERA FBS"
 EN Series "PADERA FBS"
 DE Serie "PADERA FBS"
 IT Serie "PADERA FBS"

m=10 kg

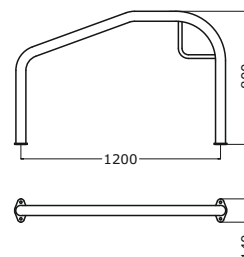

4011

HR Serija "PADERA FBS-W1" sa reklamnim prostorom
 EN Series "PADERA FBS-W1" with advertizing space
 DE Serie "PADERA FBS-W1" mit Werbe-Raum
 IT Serie "PADERA FBS-W1" con lo spazio pubblicitario

m=85 kg

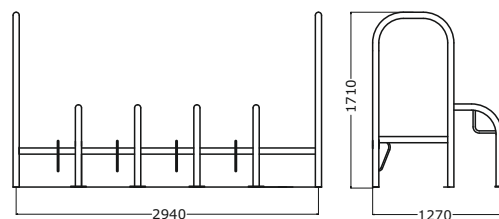

Stalci za bicikle · Bicycle stands · Fahrradständer · Porta biciclette



4012

HR Serija "PADERA FBS-W2" sa reklamnim prostorom
 EN Series "PADERA FBS-W2" with advertizing space
 DE Serie "PADERA FBS-W2" mit Werbe-Raum
 IT Serie "PADERA FBS-W2" con lo spazio pubblicitario

m=85 kg

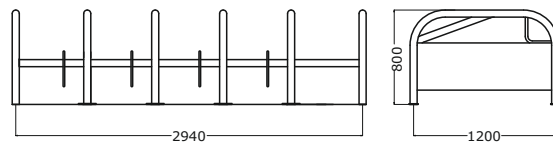

HR

Novo – Stalak za bicikle na kat

Stalak za bicikle je izrađen od pocinčanog čelika zaštićenog zapečenim prahom. Sistemi s oprugama omogućuju lagano dizanje i spuštanje bicikala.

EN

NEW - bicycle stand on storey

Bicycle stands are made from zinc-plated steel protected with powder coating. Systems with springs allow easy lifting and lowering the bicycles.

DE

NEU – Hoch Parksysteem

Fahrradständer aus dem verzinkten Stahl gemacht, mit den Pulverbeschichtung geschützt. Die Systeme mit den federn ermöglichen eine lichte Auf-und Herabsetzung der Fahrräder.

IT

Nuovo – i portabiciclette a due piani.

Il Portabiciclette è fatto dal acciaio zincato protetto dal rivestimento della polvere. I sistemi con la molla fa possibile una facile sollevazione ed abbassamento della bicicletta.



4215

HR HOPS sistem
 EN HOPS system
 DE HOPS system
 IT HOPS sistema

m=48 kg

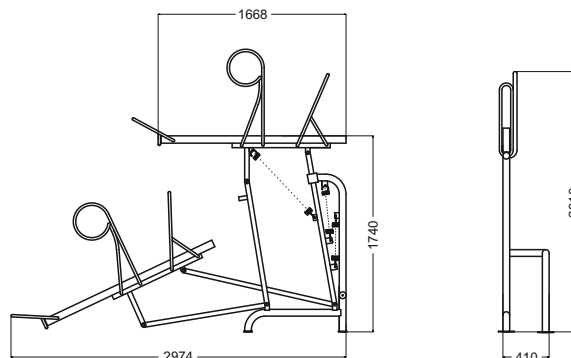

Stalci za bicikle · Bicycle stands · Fahrradständer · Porta biciclette

HR Stalci za bicikle su izrađeni od pocinčanog čelika zaštićenog zapečenim prahom. Postavljeni su na masivne armirane žardinjere od pravog kulira.

EN Bicycle stands are made from zinc-plated steel protected with powder coating. They are placed on a massive steel reinforced flower-stands made of real exposed aggregate concrete.

DE Die Fahrradständer aus dem verzinkten Stahl gemacht und mit dem Pulverbeschichtung geschützt. Die sind auf den massive armierte Blumentröge von Echte Waschbeton.

IT I portabiciclette sono fatti dal acciaio zincato e protetti dal rivestimento della polvere. Sono postati sulle giardiniere massive e rinforzato dal cemento a vista.



4100

m=123 kg

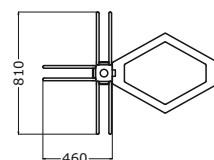
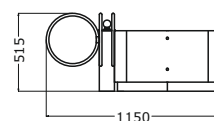

4101

m=136 kg

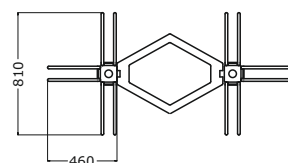
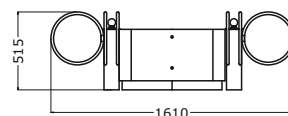

4201

m=249 kg

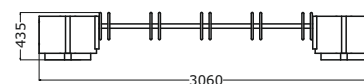
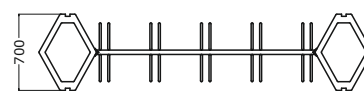

Stalci za bicikle · Bicycle stands · Fahrradständer · Porta biciclette



4202

m=239 kg

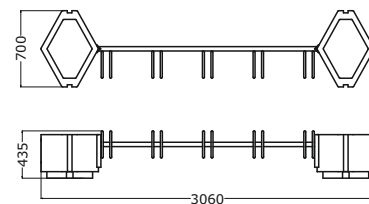

HR Stalak za bicikle je izrađen od nehrđajućeg čelika AISI 304.

EN Bicycle stand is made from stainless steel AISI 304.

DE Fahrradständer aus dem Rostfreistahl AISI 304 hergestellt.

IT Il portabiciclette è fatto dal acciaio inox AISI 304.



4001

m=39 kg

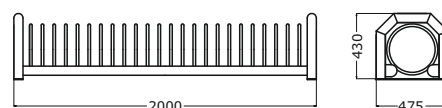

VOJTEK

Tvornica urbane opreme, sportskih i dječjih igrališta
Factory of urban equipment, sport and children playgrounds
Fabrik den Stadt- Ausrüstung, Sport und Kinderspielplätze
Fabbrica il urbano attrezzatura, terreni sportivi e campi da gioco

Bele Bartoka 13
31300 Beli Manastir

tel: +385(0)31 700 267
fax: +385(0)31 705 083

e-mail: vojtek@vojtek.hr
web: www.vojtek.hr